

Operating Instructions

"The model number and serial number of this product may be found on the bottom cover. Please write these numbers in the spaces, below, and retain this booklet for future reference, and as a permanent record of your purchase to aid identification in the event of theft."

Model No.: _____ Serial No.: _____

High Power Cassette / Weatherband Receiver

CQ-2100BEU

High Power Cassette/Receiver

CQ-2000BEU

High Power AM/FM Weatherband Receiver

CR-W200EU

Operating Instructions



Panasonic®

Please read these instructions completely before operating this unit.

**Panasonic Consumer Electronics
Company, Division of Matsushita
Electric Corporation of America**
One Panasonic Way, Secaucus,
New Jersey 07094

Panasonic welcomes you to our ever growing family of electronic product owners. We know that this product will bring you many hours of enjoyment. Our reputation is built on precise electronic and mechanical engineering, manufactured with carefully selected components and assembled by people who take pride in their work. Once you discover the quality, reliability, and value we have built into this product, you too will be proud to be a member of our family.

Use This Equipment Safely When Driving

Keep the volume level low enough to be aware of road and traffic conditions.

When Vehicle Washing

Do not expose the equipment, including the speakers and tapes, to water or excessive moisture. This could cause electrical shorts, fire, or other damage.

When Parked

Parking in direct sunlight can produce very high temperatures inside your vehicle. Give the interior a chance to cool down before switching the unit on.

Use the Proper Power Supply

This equipment is designed to operate off a 12 volt, negative ground battery system (the normal system in a North American vehicle.)

Protect the Tape Mechanism

Keep magnets, screwdrivers, or other metallic objects away from the tape mechanism and tape head to prevent poor performance or malfunctions.

Use Authorized Servicenters

Do not attempt to disassemble or adjust this precision equipment. Please refer to the Servicenter list included with this product for service assistance.

Note:

This operating instruction manual is for both models CQ-2100BEU/CQ-2000BEU and CR-W200EU. All illustrations throughout this manual represent model CQ-2100BEU unless otherwise specified. The following table describes the differences between three models.

Model	Weather Band	Cassette Player
CQ-2100BEU	Yes	Yes
CQ-2000BEU	No	Yes
CR-W200EU	Yes	No

Installation Guide

 **WARNING**

This installation information is designed for experienced installers and is not intended for non-technical individuals. It does not contain warnings or cautions of potential dangers in attempting to install this product.

Any attempt to install this product in a motor vehicle by anyone other than qualified installer could cause damage to the electrical system and could result in serious personal injury or death.

Overview

This equipment should be installed by a professional. However, if you plan to install this unit yourself, your first step is to decide where to install it. The instructions in these pages will guide you through the remaining steps: (Please refer to "WARNING" statement above).

- Identify and label the vehicle wires
- Connect the vehicle wires to the wires of the power connector
- Install the unit in the dash
- Check the operation of the unit







If you do encounter problems, please consult your nearest professional installer.

CAUTION: This unit will operate with a 12 volt DC negative ground auto battery system only. Do not attempt to use it in any other system. Doing so could cause serious damage.

Before you begin installation, look for the following items included in the packing with your unit.

- **Warranty Card** Fill this out promptly
- **PASC Servicenter Directory** Keep for future reference in case the unit needs servicing
- **Installation Hardware** Needed for in-dash installation

Installation Hardware

No.	Item	Diagram	Qty
①	Mounting Collar		1
②	Hex. Nut (5 mm Ø)		1
③	Rear Support Strap		1
④	Tapping Screw (5mm Ø X 16mm)		1
⑤	Power Connector (only for CQ-2100BEU /CQ-2000BEU)		1
⑥	Dismounting Pin		1
⑦	Trim Plate		1

□ Required Tools

You'll need a screwdriver, a 1.5 volt AA battery, and the following:

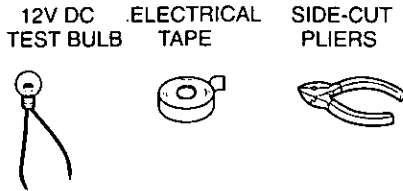

□ Dashboard Specifications

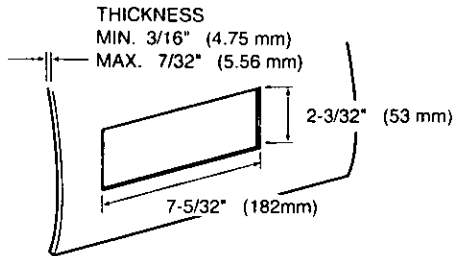

□ Identify All Leads

The first step in installation is to identify all the vehicle wires you'll use when hooking up your sound system. As you identify each wire, we suggest that you label it using masking tape and a permanent marker. This will help avoid confusion when making connections later.

Note: Do not connect the power connector to the stereo unit until you have made all connections. If there are no plastic caps on the stereo hooking wires, insulate all exposed leads with electrical tape until you are ready to use them. Identify the leads in the following order.

Power Lead

If your vehicle has a radio or is pre-wired for one:

Cut the connector plug off (leaving the leads as long as possible) so that you can work with individual leads.

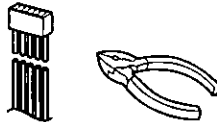

Turn the ignition on to the accessory position, and ground one lead of the test bulb to the chassis.

Touch the other lead of the test bulb to each of the exposed wires from the cut radio connector plug. Touch one wire at a time until you find the outlet that causes the test bulb to light.

Now turn the ignition off and then on. If the bulb also turns off and on, that outlet is the vehicle power lead.

If your vehicle is not wired for an audio unit: Go to the fuse block and find the fuse port for radio (RADIO), accessory (ACC), or ignition (IGN).

Battery Lead

If your stereo unit has a yellow lead, you will need to locate the vehicle's battery lead. Otherwise you may ignore this procedure. (The yellow battery lead provides continuous power to maintain a clock, memory storage, or other function.)

If your vehicle has a radio or is pre-wired for one: With the ignition and headlights off, identify the vehicle battery lead by grounding one lead of the test bulb to the chassis and checking the remaining exposed wires from the cut radio connector plug.

If your vehicle is not wired for an audio unit: GO to the fuse block and find the fuse port for the battery, usually marked BAT.

Speakers

Identify the vehicle speaker leads. There will be two leads for each speaker, usually color coded.

A handy way to identify the speaker leads and the speaker they connect with is to test the leads using a 1.5 volt AA battery as follows.

Hold one lead against one pole of the battery and stroke the other lead across the other pole. You will hear a scraping sound in a speaker if you are holding a speaker lead. If not, keep testing different lead combinations until you have located all the speaker leads. When you label them, include the speaker location for each.

Antenna Motor

If your vehicle is equipped with an automatic power antenna, identify the vehicle motor antenna lead by connecting one bulb tester lead to the vehicle battery lead and touching the remaining exposed wires from the cut radio connector plug one at a time. You will hear the antenna motor activate when you touch the correct wire.

Antenna

The antenna lead is a thick, black wire with a metal plug at the end.

□ Connect All Leads

Now that you have identified all the wires in the vehicle, you're ready to begin connecting them to the stereo unit wires. The connection diagram on **Installation Guide** shows the proper connections and color coding of the leads.

We strongly recommend that you test the unit before making a final installation.

You can set the unit on the floor and make temporary connections to test the unit. Use electrical tape to cover all exposed wires.

IMPORTANT : Connect the red power lead last, after you have made and insulated all other connections.

Ground

Connect the black ground lead of the power connector to the metal vehicle chassis.

Speakers

Connect the speaker wires. See the wiring diagram below for the proper hookups. Follow the diagram carefully to avoid damaging the speakers, and the stereo unit.

The speaker used must be able to handle more than 25 watts of audio power. Speakers with low input ratings can be damaged.

Speaker impedance should measure 4-8 ohms, which is typically marked on most speakers. Lower or higher impedance speakers will affect output and can cause both speaker and stereo unit damage.

CAUTION: Never ground the speaker cords. For example, do not use a chassis ground system or a three-wire speaker common system. Each speaker must be connected separately using parallel insulated wires. If in doubt about how your vehicle's speakers are wired, please consult with your nearest professional installer.

CORRECT
No Common Ground

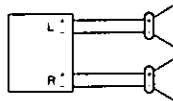

INCORRECT
Common Chassis Ground

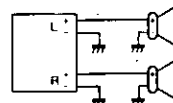

INCORRECT
Speaker Common
(common earth lead)

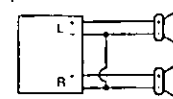

Motor Antenna

Connect the vehicle motor antenna lead to the blue motor antenna relay control lead.

Battery

Connect the yellow battery lead to the correct radio wire or to the battery fuse port on the fuse block.

Antenna

Connect the antenna by plugging the antenna lead into the antenna receptacle.

Equipment

Connect any optional equipment such as amplifier, according to the instructions furnished with the equipment. Keep about 12 inches (30 cm) of distance between the speaker cords/amplifier unit and the antenna/antenna extension cord. Read the operating and installation instructions for any equipment you will connect to this unit.

Power

Connect the red power lead to the correct vehicle radio wire or to the appropriate fuse port on the fuse block.

If the stereo unit functions properly with all these connections made, disconnect the wires and proceed to the final installation.

Final Checks

1. Make sure that all wires are properly connected and insulated.
2. Make sure that the stereo unit is securely held in the mounting collar.
3. Turn on the ignition to check the unit for proper operation.

If you have difficulties, consult your nearest authorized professional installer for assistance.

Final Installation

Lead connections

Connect all wires, making sure that each connection is insulated and secure. Bundle all loose wires and fasten them with tape so they won't fall down later. Now insert the stereo unit into the mounting collar.

Congratulations! After making a few final checks, you're ready to enjoy your new auto stereo system.

Installation Procedures

1. Secure the Mounting Collar ①

Insert Mounting Collar ① into the vehicle's dashboard, and bend mounting tabs out with a screwdriver.

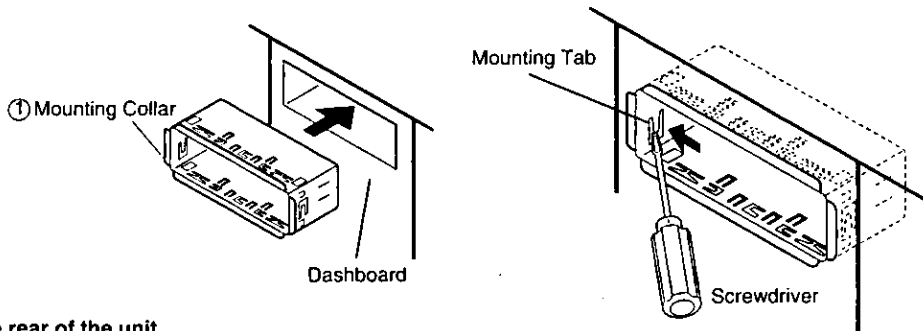

2. Secure the rear of the unit.

- a) Check the electrical connection by referring to this operating instructions.
- b) Insert the unit into Mounting Collar ① and push it in until "click" is heard.

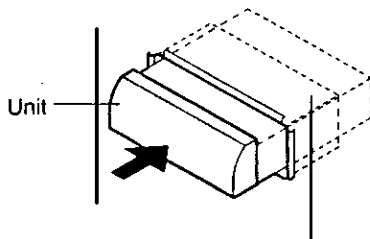

- c) Secure the rear of the unit to the vehicle by either of the two recommended methods.

■ **Using the Rear Support Strap ③**

Affix one end of the Rear Support Strap ③ to the rear of the unit, and the other end to the Fire Wall of vehicle, or some other metallic area.

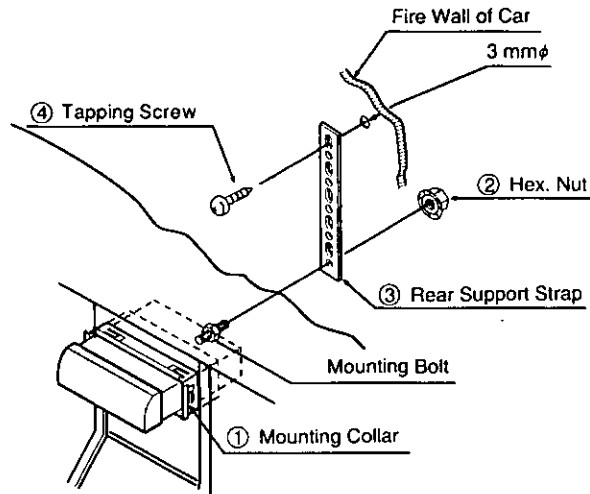

■ **Using the Rubber Cushion (Optional)**

(If there is an existing Rear Support Bracket on the Fire Wall of vehicle.)

Cover Mounting Bolt on the rear of the unit with Rubber Cushion (Optional), and mount it into the existing Rear Support Bracket.

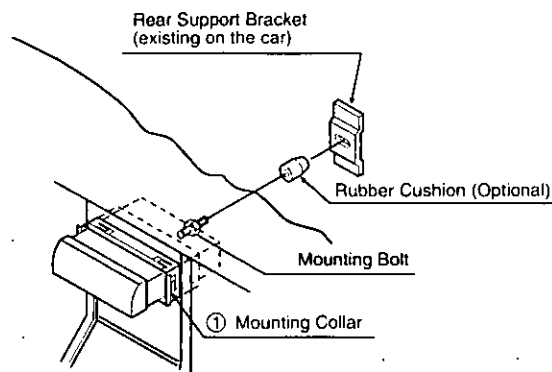

3.a) **Plug the Power Connector ⑤**

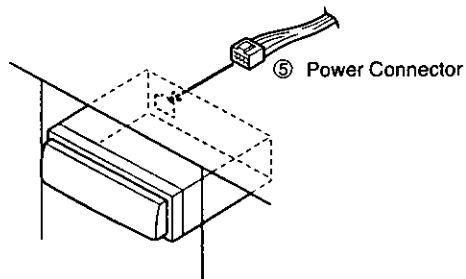

4. After installation reconnect the negative (—) battery terminal.

To Remove the Unit from the vehicle's dashboard

- a) Remove the Trim Plate ⑦ with a screwdriver as shown in the figure.
- b) Push the Dismounting Pin ⑥ in as far as possible.

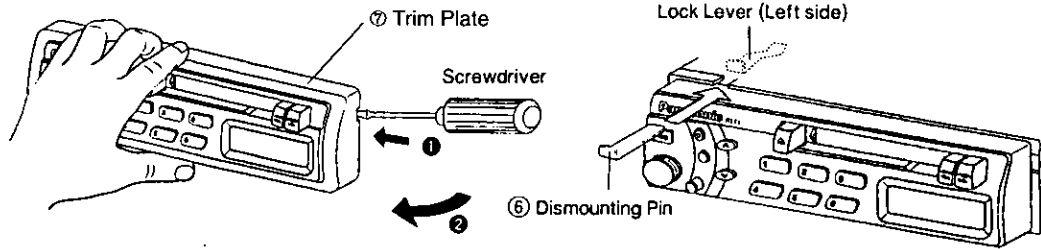

c) Pull out the unit while pushing the lock lever (Right Side) using a screwdriver.

d) Remove the unit pulling with both hands.

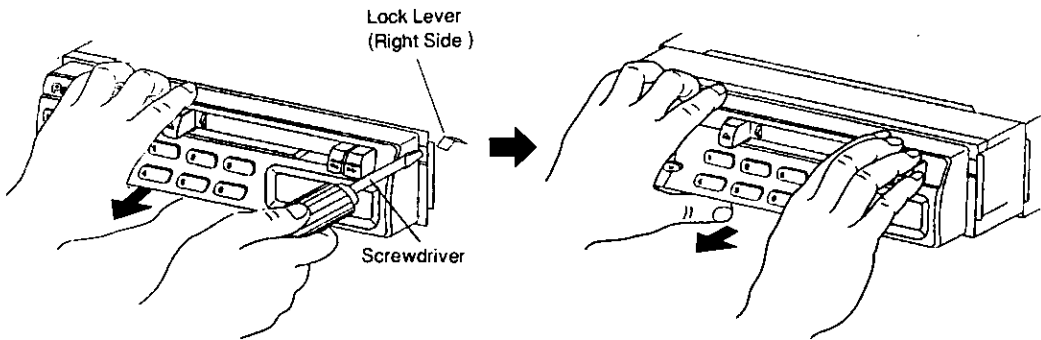

Caution:

- To prevent damage to the unit, be sure to follow the connection diagram below.
 - Remove the covering of the leads about 5 mm long from their end before connecting.
 - Do not insert the power connector into the unit until the wiring is completed.
 - Be sure to insulate any exposed wires from a possible short-circuit from the vehicle chassis.
- Bundle all cables and keep cable terminals free from touching any metal parts.

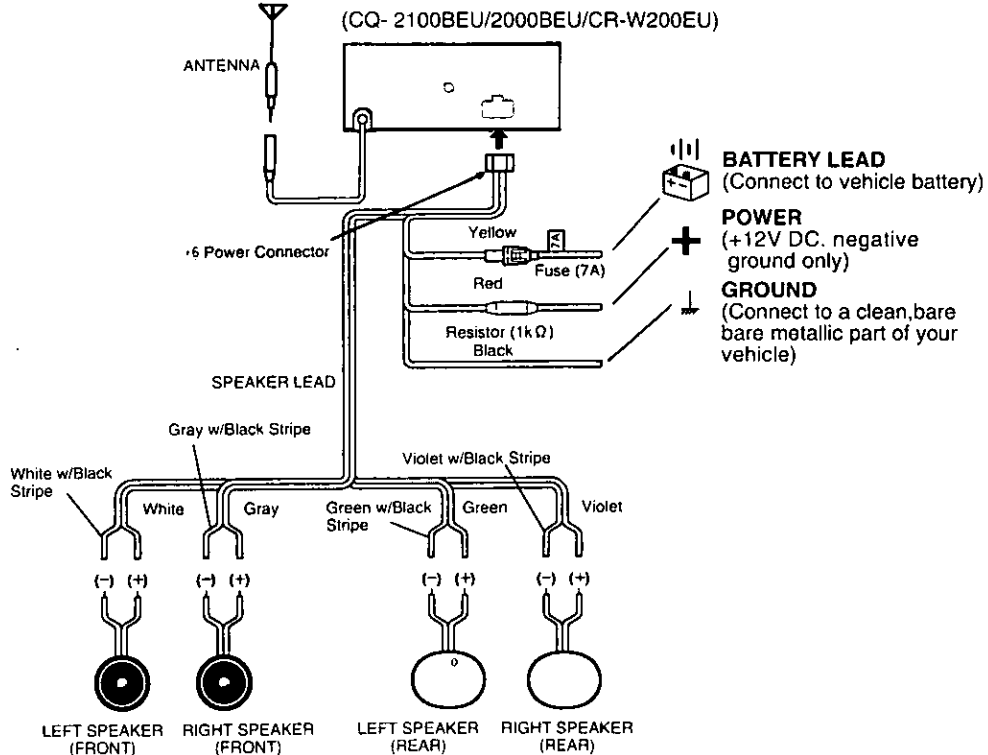

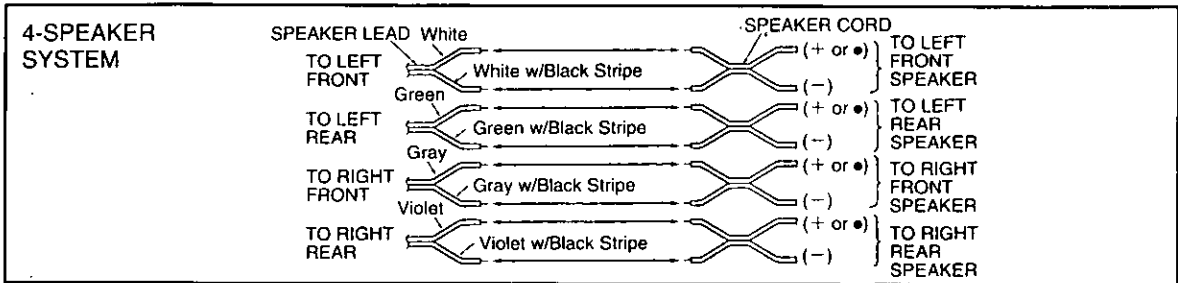
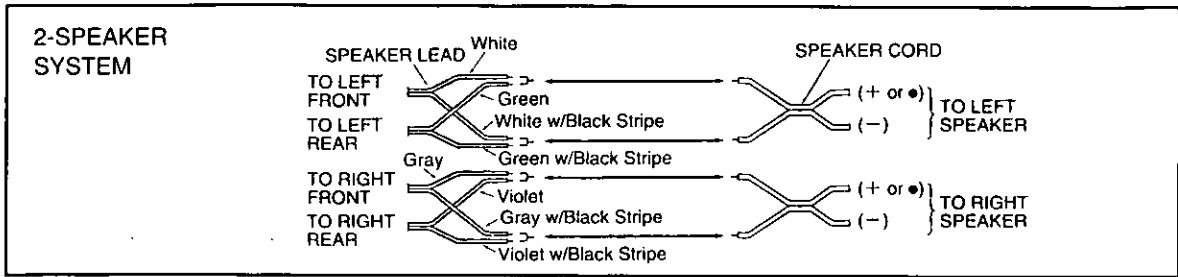

Troubleshooting

Maintenance

Your product is designed and manufactured to ensure a minimum of maintenance. Use a soft cloth for routine exterior cleaning. Never use benzine, thinner, or other solvent.

When Something Doesn't Work

Check the charts on **Troubleshooting Tips** for possible causes and solutions to any problem you might be experiencing. Some simple checks or minor adjustments may eliminate the problem.

Product Servicing

If the suggestions in the charts don't solve the problem, we recommend that you take it to your nearest authorized PASC Servicenter. The unit should be serviced only by a qualified technician.

Replacing the Fuse

Use fuses of the same specified rating (7 amps). Using different substitutes or fuses with higher ratings, or connecting the unit directly without a fuse, could cause fire or damage to the stereo unit.

If the replacement fuse fails, contact your nearest PASC Servicenter for service.

□ Notes on Cassette tapes

Tape Slack:

Use a pencil or similar object to take up the slack as shown. If a loose tape is used, this may result in the tape becoming tangled in the rotating parts of the unit.

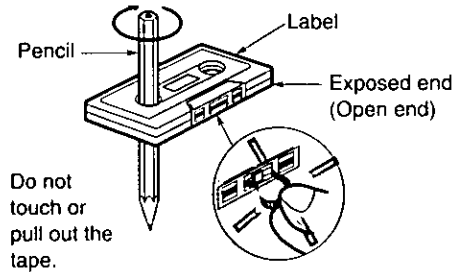

□ Troubleshooting Tips

PROBLEM	POSSIBLE CAUSE	PROBABLE SOLUTION
Unit won't turn on.	Dead vehicle battery. Ignition not on. Bad power line connection. Fuse burned out.	Charge vehicle battery. Turn ignition to On or Accessory. Check connections. Replace fuse.
Radio has static	Antenna not hooked up. Close to high power lines .	Hook up antenna. Move away from high power lines.
Radio memory buttons don't work.	Not holding buttons down long enough.	Press and hold buttons for more than 2 seconds.
Tape sound quality is poor.	Heads are dirty. Poor quality tape.	Clean heads. (Ask a service representative for advice.) Use better quality tape.
Tape won't change programs.	Not pressing ►► and ◄◄ buttons at the same time.	Press ►► and ◄◄ buttons at the same time.

Power and Sound Controls

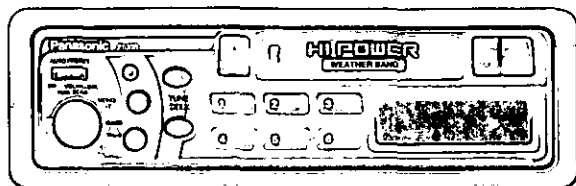

(CQ-2100BEU)

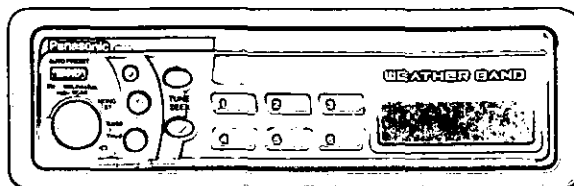

(CR-W200EU)

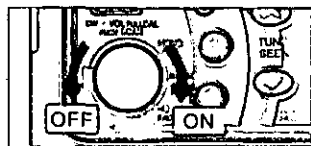

Power

Turn the ignition key on.
Turn the knob clockwise to switch on the power.
When turn off the power, clock will also show on the display.

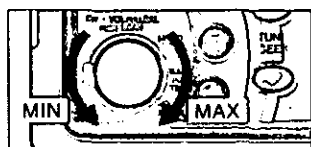

Volume

Turn the knob clockwise to increase volume, and counterclockwise to decrease volume.

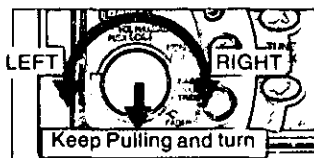

Balance

Keep pulling the knob and turn it to the left or right to shift the sound volume to the left or right speakers.

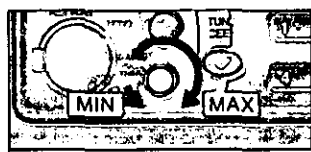

Bass and Treble

Bass control : Turn the knob to adjust bass response.

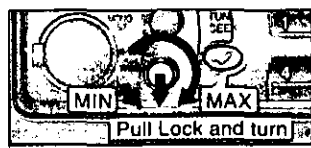

Treble control: Pull and lock the knob and turn to adjust treble response.
After adjusting, press the knob in.

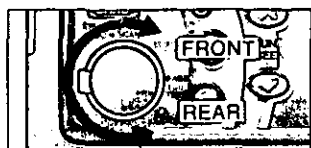

Fader

Turn to the left or right to shift the sound volume to the front or rear speakers.

Radi0 Basics

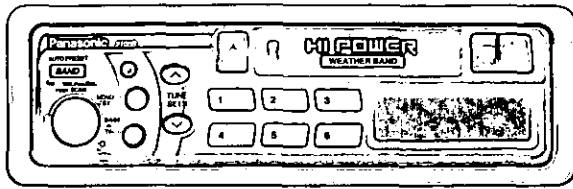

(CQ-2100BEU)

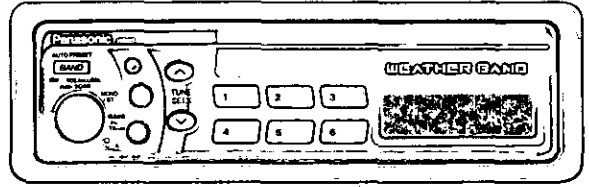

(CR-W200EU)

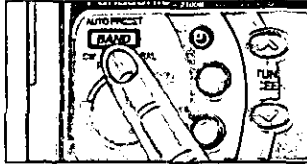

Selecting a Band

- It can not be changed to radio mode while tape playing. If you want to change radio mode, eject the tape.
- Press BAND to select the bands in the following order.
FM1 → FM2 → FM3 → AM FM1 → FM2 → AM → WB(Weather Band)

↑
(Only for CQ-2000BEU)

↑
(Only for CQ-2100BEU/CR-W200EU)

“ST” indicator lights if the station is broadcasting in stereo.

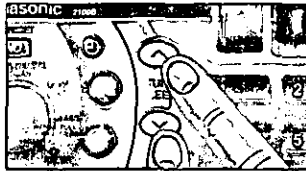

Manual Tuning

Press “^ TUNE” or “v TUNE” to move to a higher or lower frequency .



Seek Tuning

Press and hold “^ TUNE” or “v TUNE” for more than a half second, then release. The radio automatically stops on the next station.

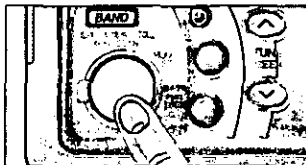

Scan Tuning

- Press the knob to scan the next stations for about 5 seconds sequentially upward.
- Press the knob again to cancel.

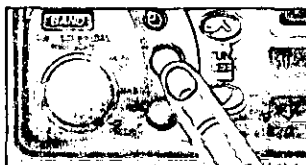

TO reduce interference during FM broadcasts

Press MONO/ST for monaural reception in case a lot of interference is present in an FM stereo signal or to improve the listening quality of weak FM broadcasts.

Preset Station Setting

Up to The stations can be preset in the station memory as follows;

FM1	FM2	FM3	AM
6 stations	6 stations	6 stations	6 stations

(Only for CQ-2000BEU)

FM1	FM2	AM
6 stations	6 stations	6 stations

(Only for CQ-2100BEU/CR-W200EU)

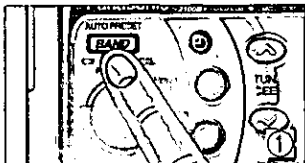

Manual Station Preset

- ① Press BAND to select a desired band.
 - ② Use manual or seek tuning to find a station that you want to program into memory.
 - ③ Press and hold one of the station selector buttons 1 through 6 until the display blinks. The memory is now set for that button on the band you have selected.
- Repeat the process to set other stations for the FM1 to AM bands

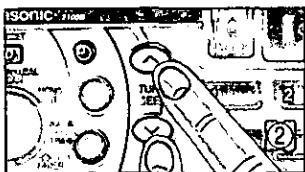

Note: You can change the memory setting by repeating the above procedure.

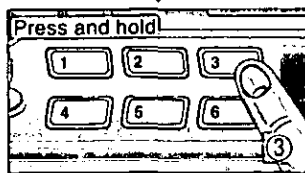

Tuning in a Preset Station

Press any of the buttons 1 through 6 to tune in the station preset by the above steps ① to ③.

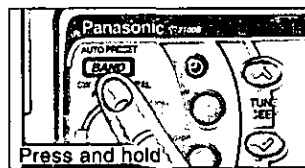

Auto Station Preset

Select a band and press and hold BAND for more than 2 seconds.

- The 6 strongest available stations will be automatically set in memory on preset buttons 1 through 6.
- Once set, the preset stations are sequentially scanned for 5 seconds.
- Press the appropriate preset button for the station you want to hear.

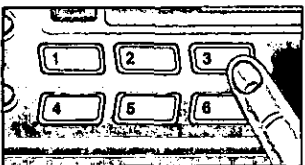

CAUTION: For safety reasons, do not attempt to program while driving.

Radio Basics continued (Only for CQ-2100BEU/CR-W200EU)

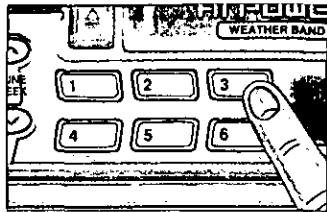

Tuning in a Weather Band Station

- Press BAND to select Weather Band.
- Press any of the buttons 1 through 6 to tune in the station preset.

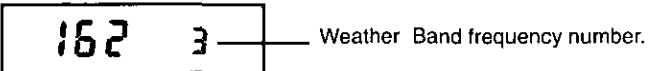

Note: The weather band (CH1-6) has been preset in advance. CH7 is selected by pressing " ^ TUNE" or " v TUNE"

Weather Band Stations

National Weather Radio Broadcasts from over 380 locations throughout the U.S. on seven VHF/FM frequencies.

Tune to weather band to receive continuous weather information 24 hours a day on one of the following frequencies.

1. 162.550 MHz
2. 162.400 MHz
3. 162.475 MHz
4. 162.425 MHz
5. 162.450 MHz
6. 162.500 MHz
7. 162.525 MHz

Occasionally the frequency of an existing or planned station must be changed because of unexpected radio frequency interference with adjacent NOAA Weather Radio Stations and with other Government or Commercial Operations within the area. If you have a question concerning NOAA Weather Radio please contact your nearest National Weather Service Office.

Cassette Tape Player Basics (Only for CQ-2100BEU/2000BEU)

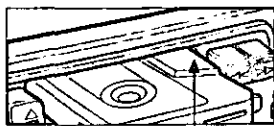
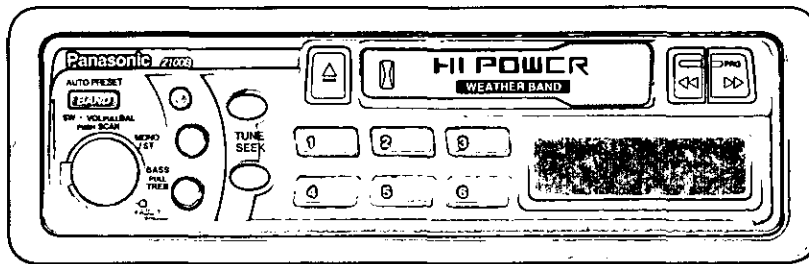

EXPOSED TAPE

Loading a Cassette

Gently insert the cassette with the exposed tape facing to the right until the mechanism captures it, and playback starts.

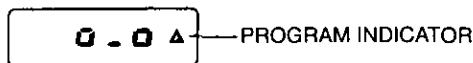

Rewind and Fast Forward

● When the program indicator (▲) lights, Press ◀◀ to rewind or press ▶▶ to fast forward the tape.

● When the program indicator (▼) lights, Press ◀◀ to fast forward or press ▶▶ to rewind the tape.

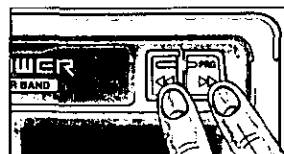

▲▲ lights: REWIND
▼▼ lights: FAST FORWARD

▲▲ lights: FAST FORWARD
▼▼ lights: REWIND

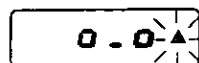

To stop rewind or fast forward, gently press the button that is not in use. The tape will resume playing from that position.

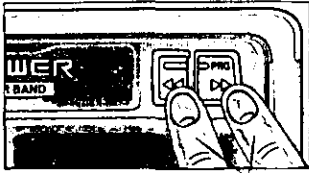

PRESS BOTH

Changing Sides

Firmly press ◀ and ▶ at the same time to switch to the program on the other side of the tape. The display changes to indicate which program is playing.



TOP SIDE
PLAYING

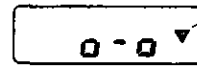

BOTTOM
SIDE
PLAYING

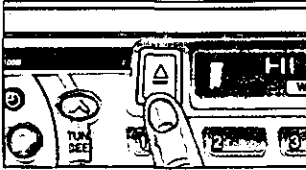

Stopping and Ejecting the Tape

Once inserted into the unit, your tape will play continuously until you eject it. If you press and engage ▲ (EJECT), the unit clears the tape and returns to radio operation.

When you shut off the car engine, the tape will stop but not eject.

Note; Always remove the cassette when you are done using the cassette player. This will prolong the life of your tape.

CAUTION ; TO maintain your cassette player in top condition, avoid using tapes that are longer than 90 minutes(C-90).

Clock Basics (The clock system is 12-hours.)

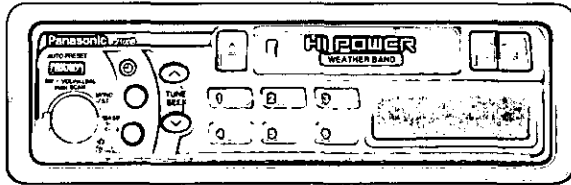

(CQ-2100BEU)

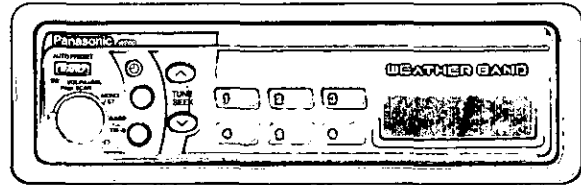

(CR-W200EU)

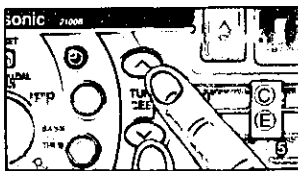
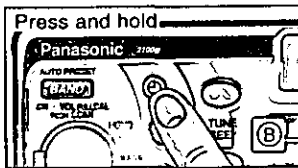

Initial Time Setting

- (A) Press ◻ "Adj" is displayed.
- (B) Press and hold ◻ again for more than 2 seconds. "12" blinks indicating the time setting mode is activated.
- (C) To set hours, press "∨ TUNE" or "TUNE ∧"
- (D) Press ◻ again for minute setting.

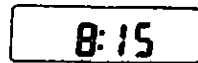
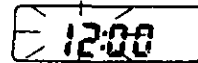
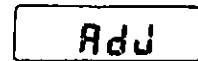

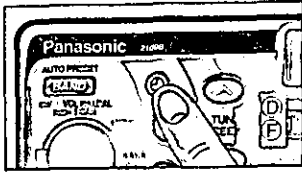

Ⓔ To set minutes, Press “ √TUNE” or “ TUNE^”

Hold “^” or “√” to change numbers rapidly.

Ⓕ When you have set the time, press Ⓞ

8:15

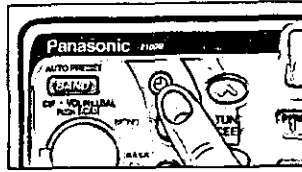

Note : Once the time setting is finished, the current time will still display after the power was off.

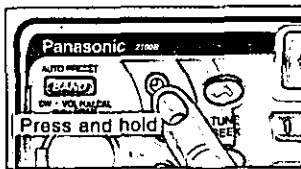

Resetting the Time

When you want to reset the time, press and hold Ⓞ for more than 2 second to activate the time setting mode. Then, repeat steps Ⓒ to Ⓕ.



Selecting the Clock Display

Press Ⓞ repeatedly to switch the display between each listening mode (Radio, Tape) and the clock.

Specifications

GENERAL

Power Supply	: 12 V DC (11V-16V) Test Voltage 14.4 V, Negative ground
Maximum Power Output	: 25 W x 2 channels at 400 Hz, Volume Control maximum
Power Output	: 11W per channel into 4 ohms, 40 to 30,000Hz at 3% THD.
Tone Action	: Bass; ± 10 dB at 100 Hz Treble; ± 10 dB at 10 kHz
Current Consumption	: Less than 2.5 A (tape mode, 0.5 W 4-speaker)
Speaker Impedance	: 4 Ω (4 - 8 Ω acceptable)
Dimensions (W x H x D)	: 7" x 1-15/16" x 5-7/8" (178 x 50 x 150mm)
Weight	: 3 lbs.8 oz. (1.6Kg)

AM RADIO

Frequency Range	: 530-1,710kHz
Useable Sensitivity	: 28 dB/ μ V (25 μ V/S/N 20 dB)

FM STEREO RADIO

Frequency Range	: 87.9-107.9MHz
Useable Sensitivity	: 12dBf. (1.1 μ V/75 Ω .S/N 30 dB)
50 dB Quieting Sensitivity	: 17dBf (1.8 μ V/75 Ω)
Frequency Response	: 30-15,000Hz ± 3 dB
Alternate Channel Selectivity	: 75 dB
Stereo Separation	: 35 dB at 1,000Hz
Signal/Noise Ratio	: 70 dB (Mono)

WB RADIO (Only for CQ-2100BEU/CR-W200EU)

Useable Sensitivity	: 3 dB/ μ V (S/N 20 dB)
Signal/Noise Ratio(40 dB/ μ V)	: 50 dB
Frequency Range	: 162.40 - 162.55 MHz

TAPE PLAYER (Only for CQ-2100BEU/2000BEU)

Reproduction System	: 4 track, 2-program stereo
Tape Speed	: 1-7/8"/sec (4.76cm/sec)
FF/REW Time	: Less than 170 sec (C-60)
Frequency Response	: 35 - 14,000 Hz ± 3 dB
Wow and Flutter	: 0.12%(WRMS)
Signal/Noise Ratio	: 52 dB

*Above specifications comply with EIA standards.

Note:

Specifications and design are subject to modification without notice due to improvements in technology.